

Floetotto
Einrichtungssysteme GmbH
An der Manufaktur 4
33334 Gütersloh
T +49 (0)5241 504740
Info @floetotto.de
www.floetotto.de

**Für die Montage
benötigen Sie
folgende
Hilfsmittel**

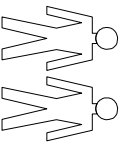

2 Personen



Inbusschlüssel
5 mm
(im Lieferumfang)



Bitte lesen Sie sich die
Aufbauanweisung
aufmerksam durch und
beachten die
Montagerihenfolge
1,2,3... bzw. A,B,C...
da wir für Fehler, die
durch falsche Montage
entstehen, keine
Haftung übernehmen
können !

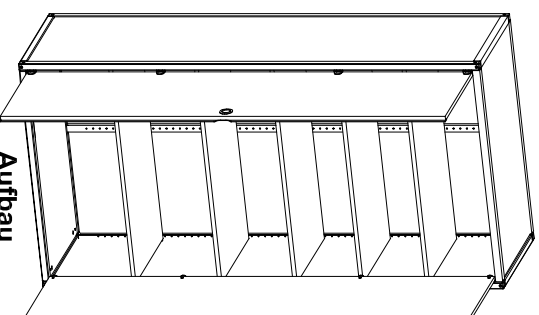
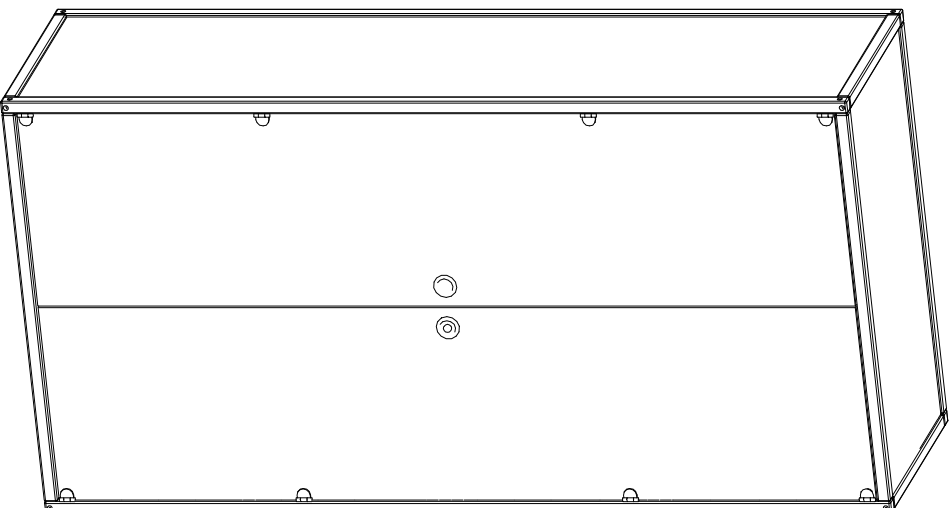

**Aufbau
Variante 1**

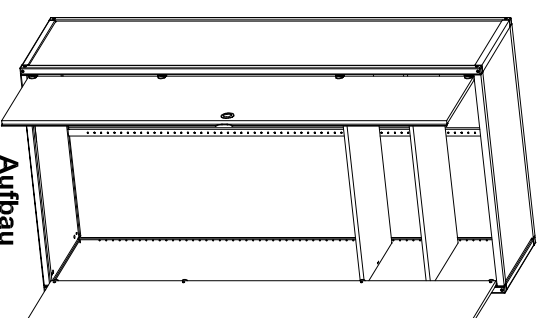



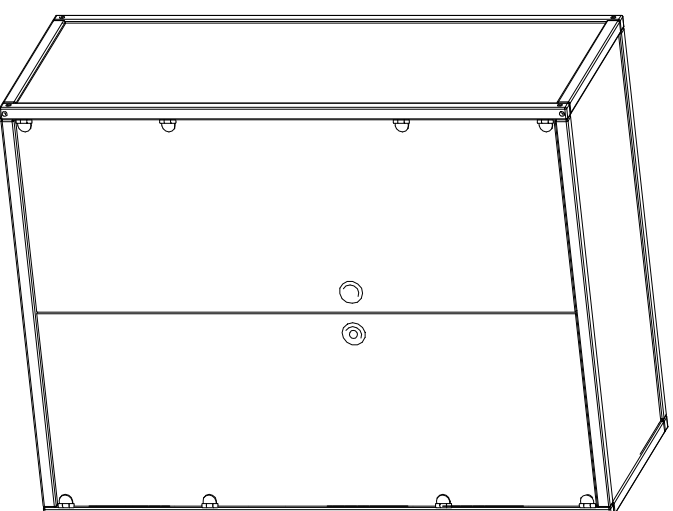







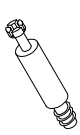

**Aufbau
Variante 2**

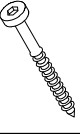

...Kleiderschrank 148cm
hoch hat insgesamt 3
Einlegeböden.

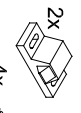

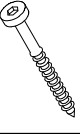
Lieferumfang

| | | | | | | | | | | | |
|----|---|----|---|-----|---|-----|---|----|---|----|--|
| 8x |  | 8x |  | 16x |  | 16x |  | 8x |  | 2x |  |
| 8x |  | 4x |  | 2x |  | 4x |  | 8x |  | 4x |  |

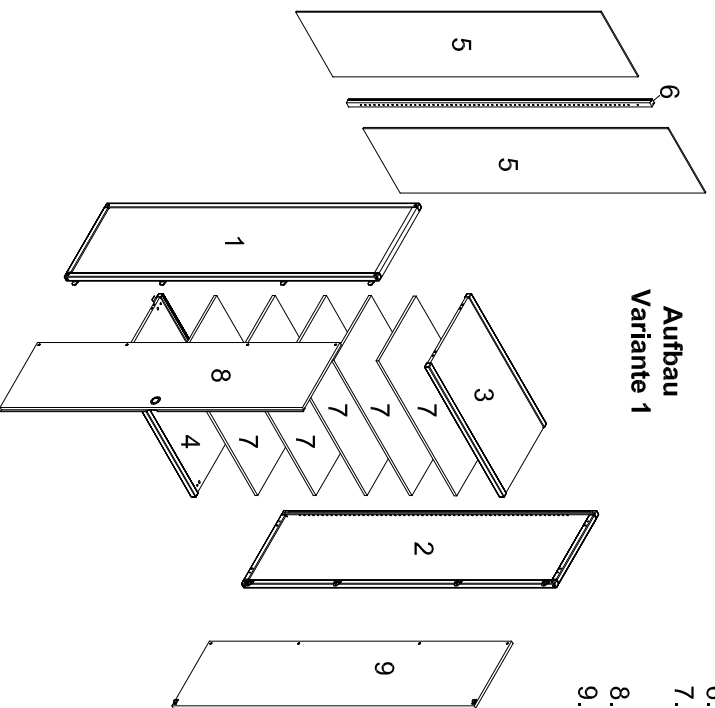





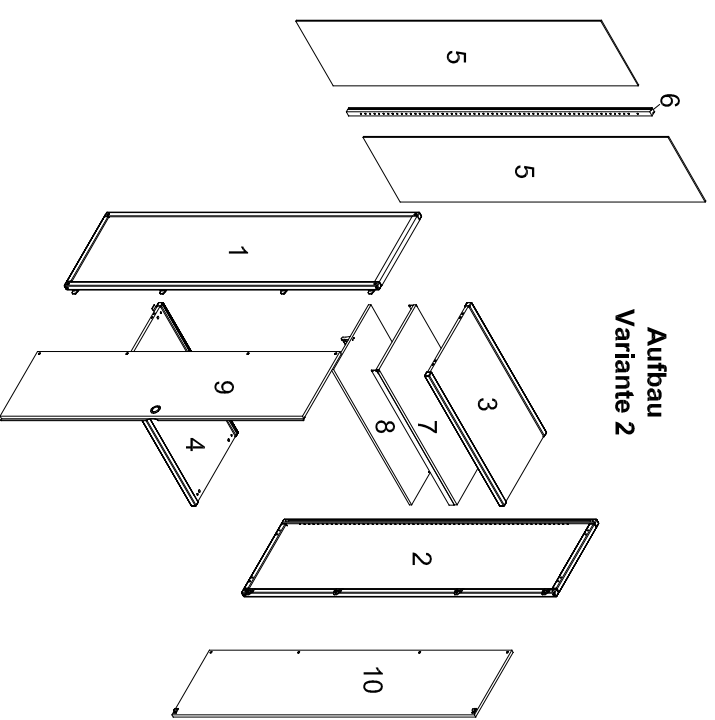



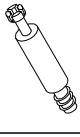

Aufbau Variante 1

1. Seite links 1x
2. Seite rechts 1x
3. Boden oben 1x
4. Boden unten 1x
5. Rückwand 2x
6. Rückwand-Pfosten 1x
7. Einlegeboden 5x (Einlegeboden 4x)
8. Drehtür links 1x
9. Drehtür rechts 1x

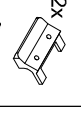

Aufbau Variante 2

1. Seite links 1x
2. Seite rechts 1x
3. Boden oben 1x
4. Boden unten 1x
5. Rückwand 2x
6. Rückwand-Pfosten 1x
7. Einlegeboden 1x
8. Kleiderboden 1x
9. Drehtür links 1x
10. Drehtür rechts 1x

| | | | | | | | | | | | |
|----|---|----|---|----|---|----|---|-----|---|----|---|
| 8x |  | 8x |  | 2x |  | 4x |  | 12x |  | 8x |  |
| 1x |  | 2x |  | 8x |  | 3x |  | 2x |  | 4x |  |

1

...schrauben Sie die
Exzenterbolzen in die
Schrankseiten.

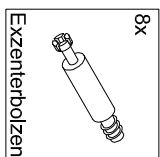
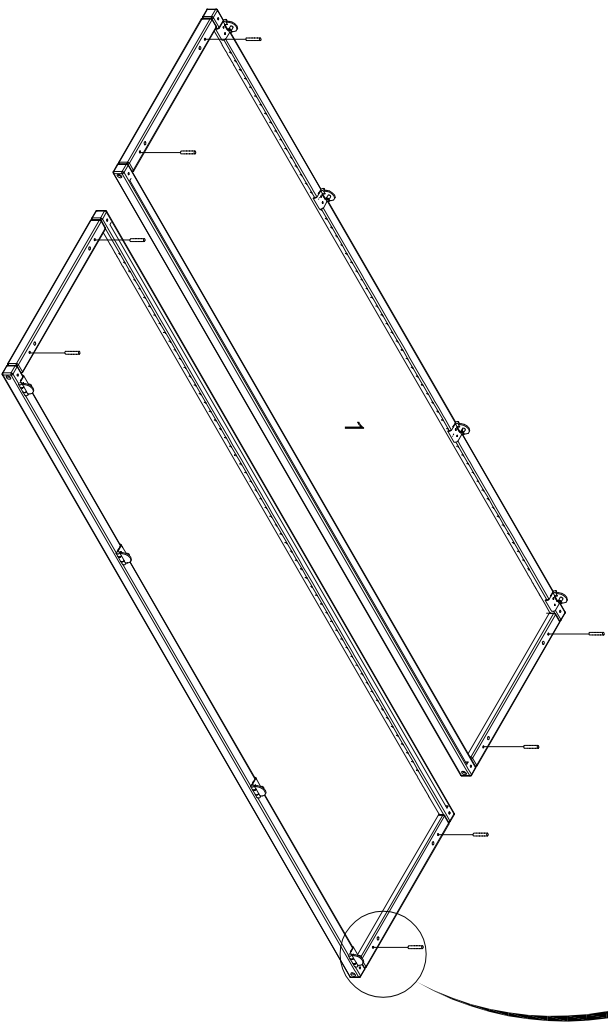
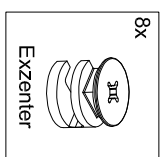
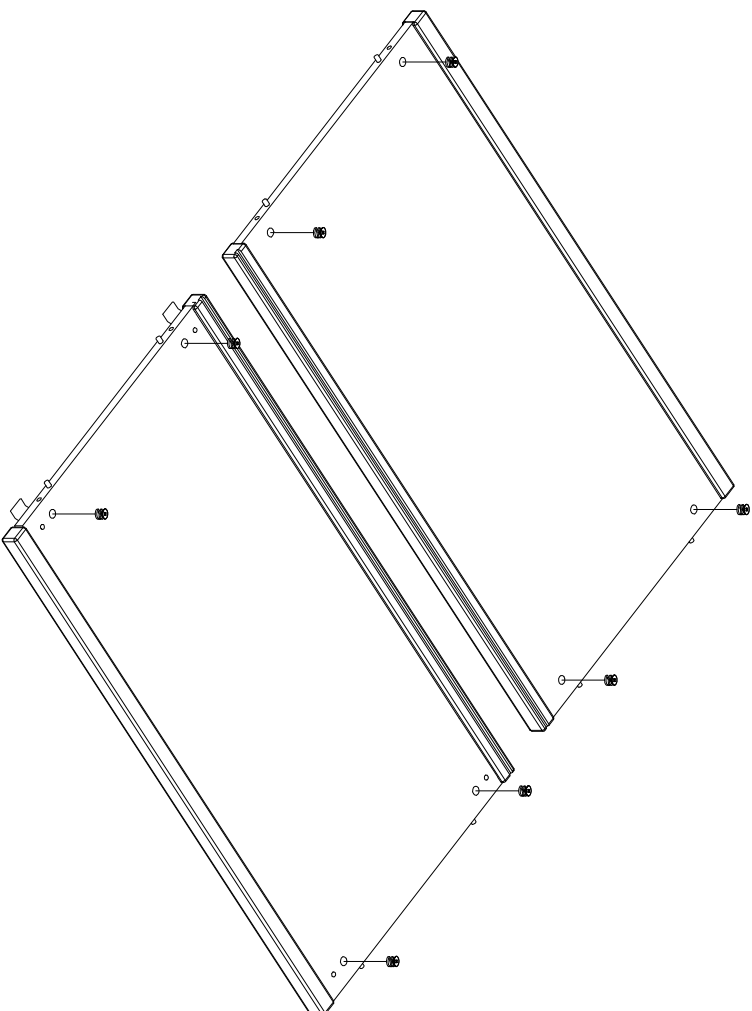
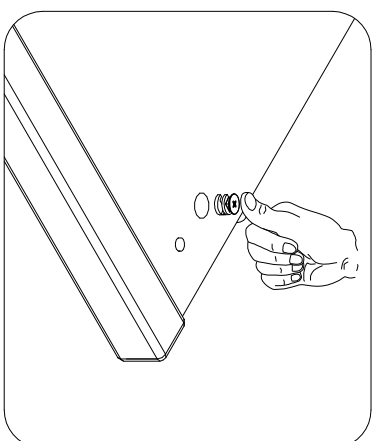
**2**



...achten Sie beim Zusammenstecken der Seiten und Rückwände auf oben und unten. Beim Rückwandpfosten und den Seiten fehlt in der Bohrrreihe jeweils eine Bohrung. Dies ist unten.

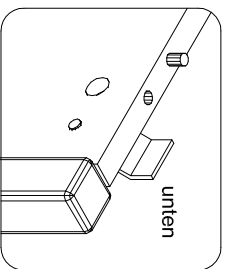
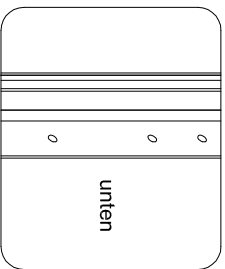

...stecken Sie den Schrank, wie abgebildet, zusammen.

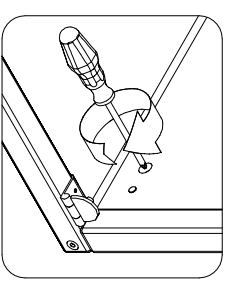
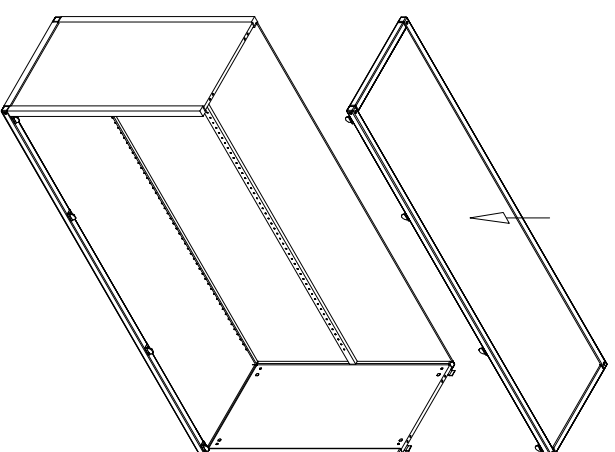
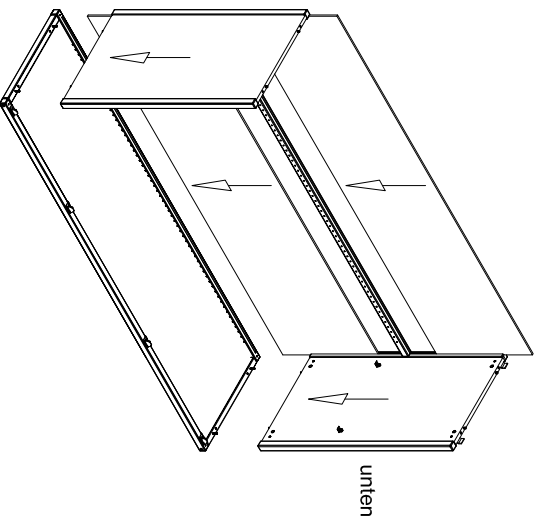

...stecken Sie den Schrank, wie abgebildet, zusammen und verschrauben den Schrank an allen vier Ecken.

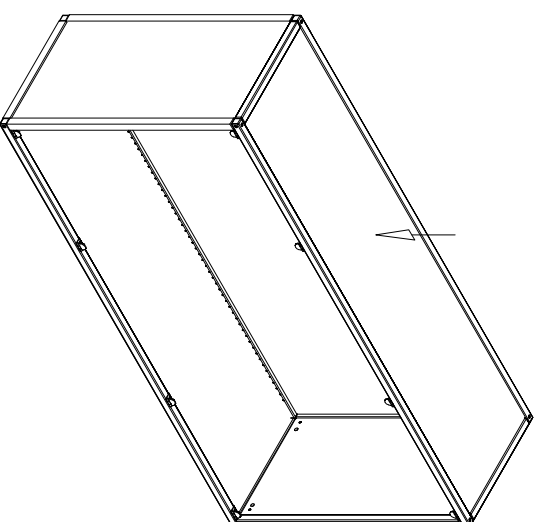

5

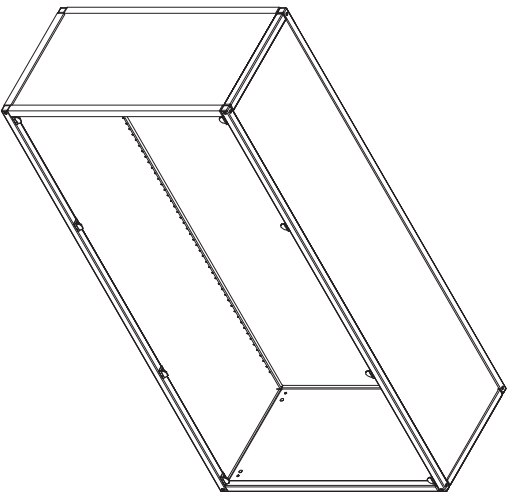

...stellen Sie den Schrank senkrecht, wie abgebildet.

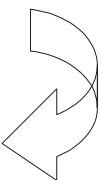

B ...verschrauben Sie den Schrank an allen vier Ecken.

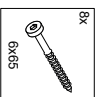
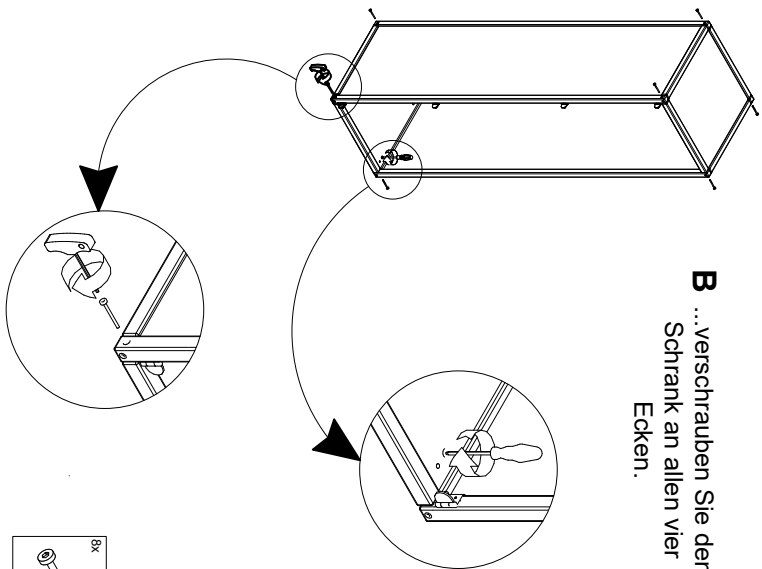

6

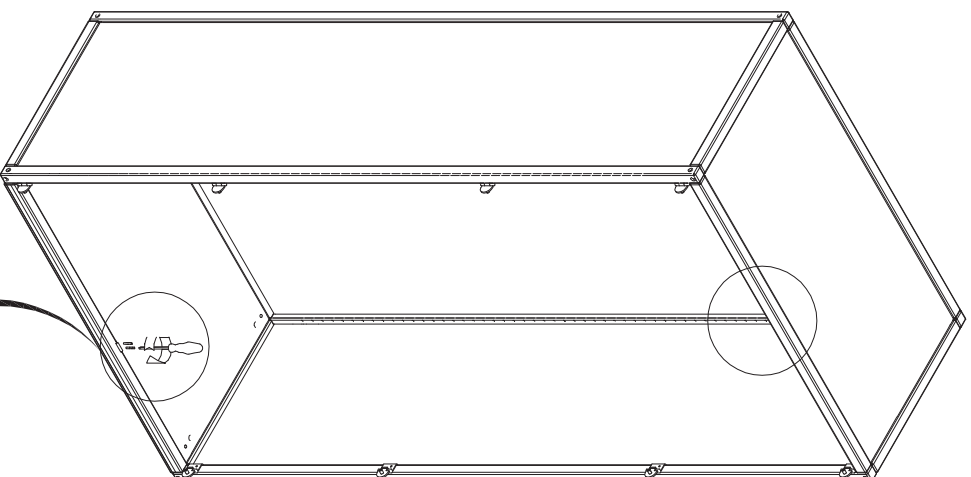

A

...kneifen Sie mit einer Zange die zwei Laschen ab.

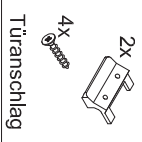
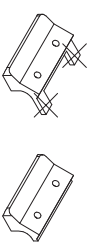

...Ansicht von innen.

B ...befestigen Sie den Türanschlag, wie abgebildet, in die dafür vorgesehenen Bohrungen oben und unten.

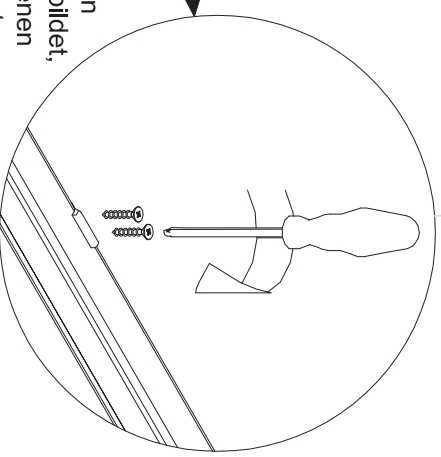

7

**Aufbau
Variante 2**

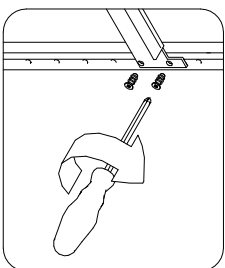
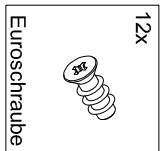
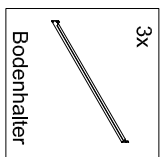
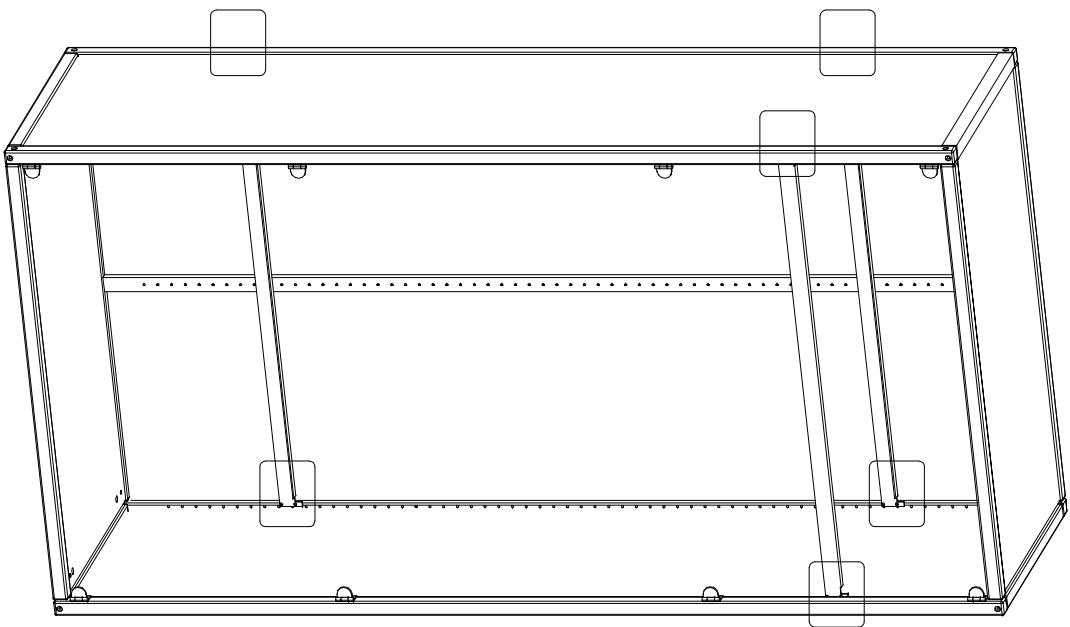

7

**Aufbau
Variante 1**

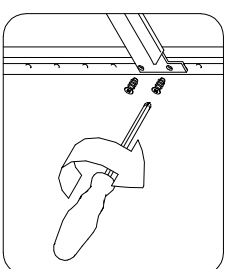
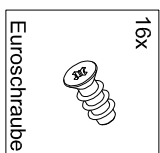
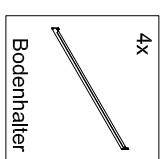
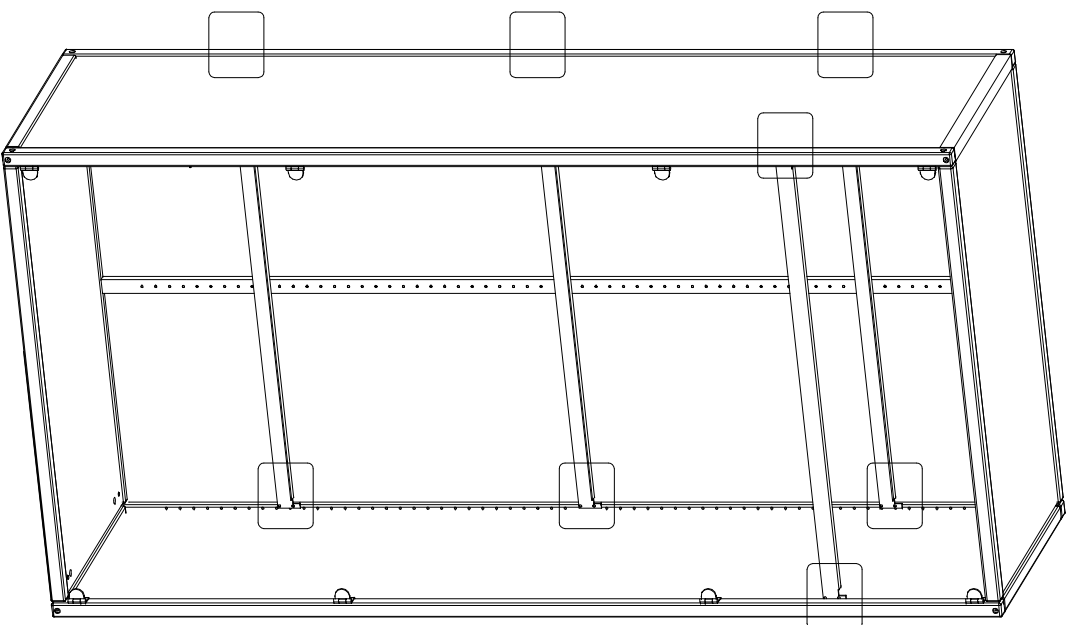

8

Aufbau
Variante 2

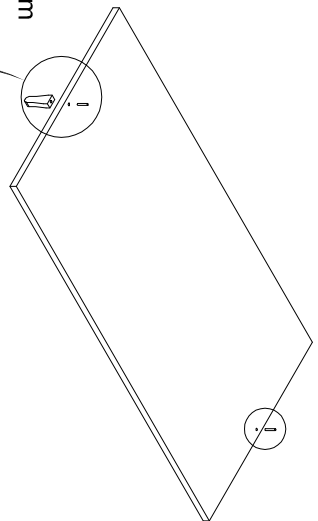

A ...befestigen Sie die
Kleiderstangenhalter am
Kleiderstangenboden

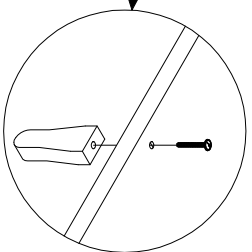
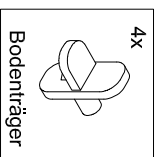
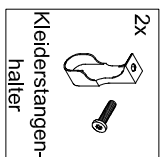

B ...stecken Sie die
Bodenträger in vier Löcher
auf der Höhe Ihrer Wahl
und legen den Boden
darauf.

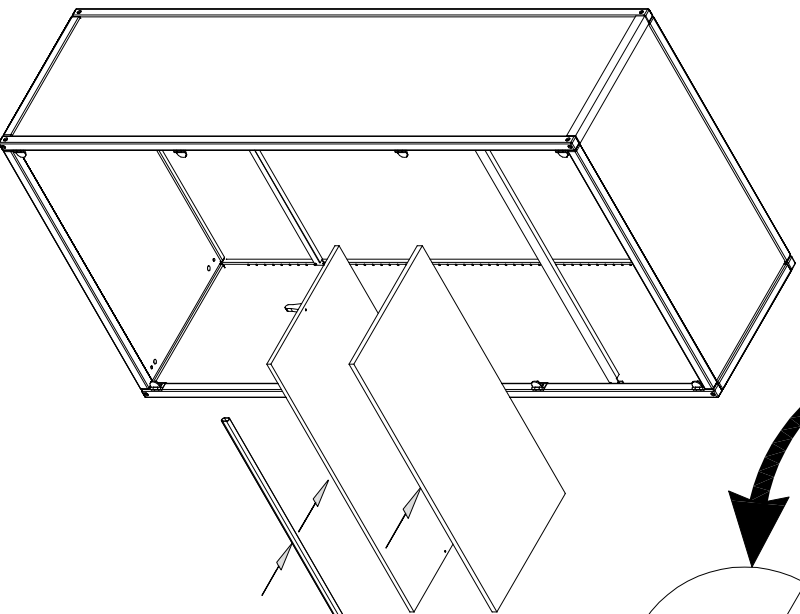
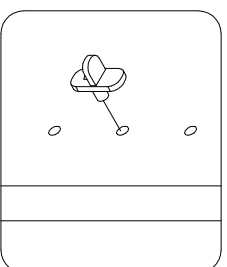

8

Aufbau
Variante 1

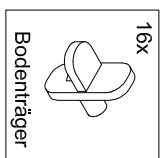

A ...stecken Sie die
Bodenträger in 4 Löcher
auf der Höhe Ihrer Wahl
und legen den Boden
darauf.

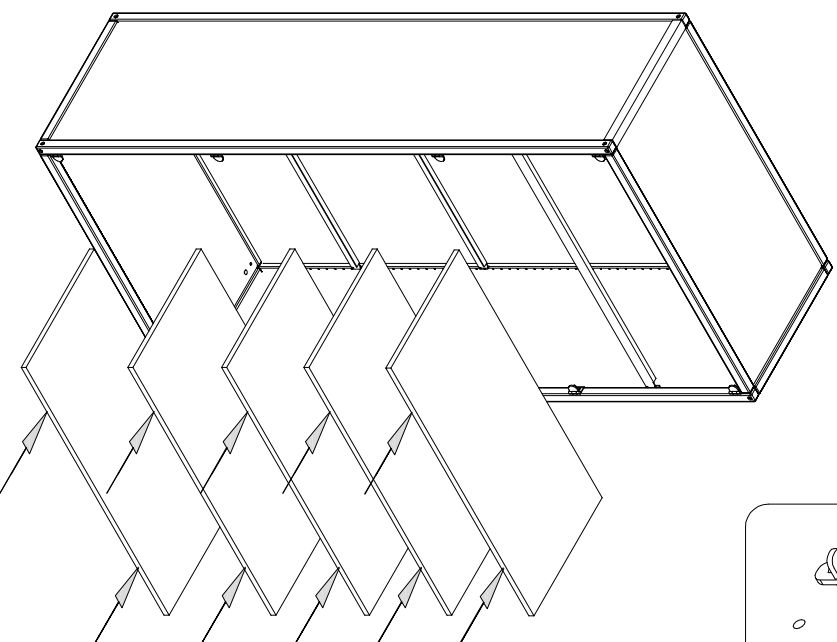
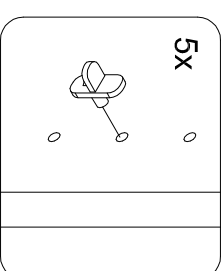

9

...befestigen Sie die Türen an den Scharnieren der Schrankseiten.

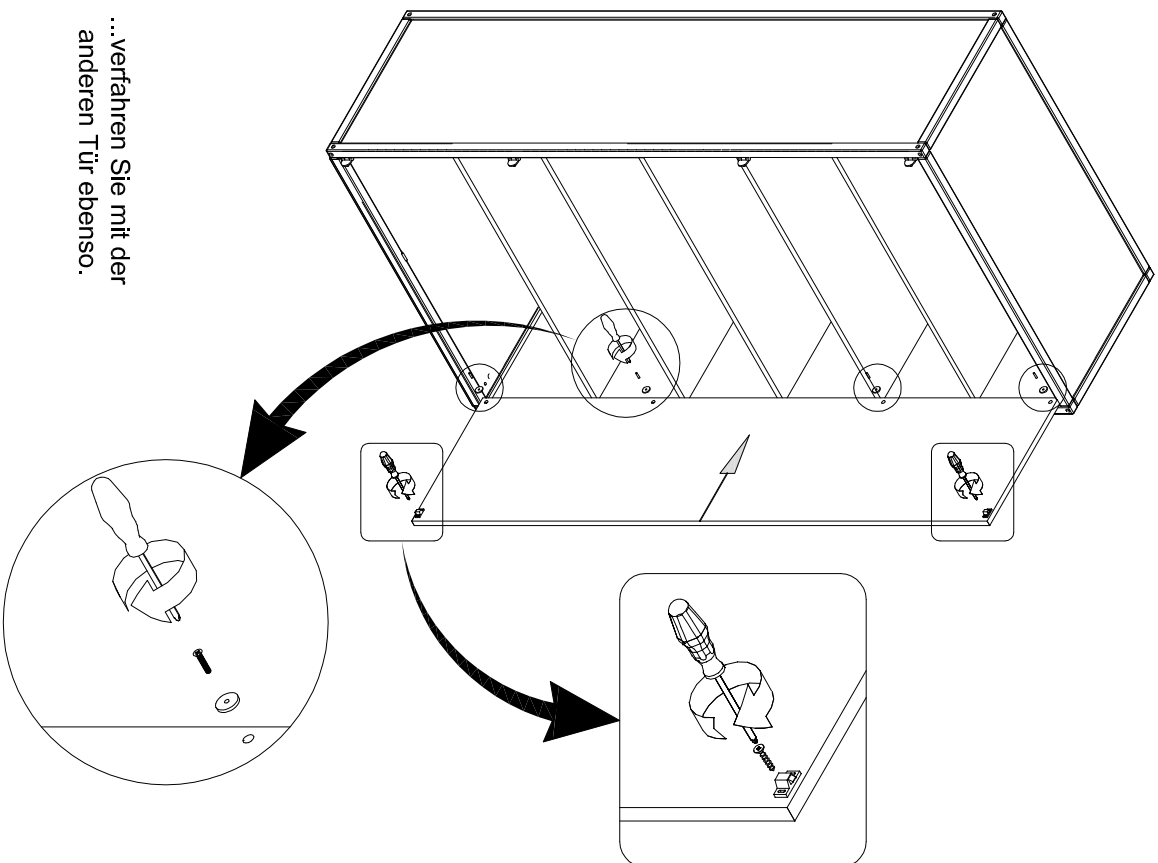
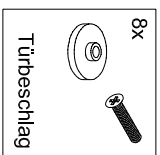
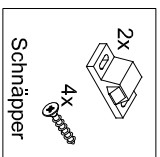

...verfahren Sie mit der anderen Tür ebenso.